

# Dayo

## FREESTANDING ACRYLIC BATH, 1500MM

### Features

- Captivating asymmetrical shape
- Freestanding design
- Chrome pop-up/pull-out waste included
- Made from UV stabilised premium sanitary-grade acrylic with Lucite MMA
- No overflow
- Built-in steel support frame
- Adjustable self-supporting feet
- Fill capacity: 200L
- Net weight: 36 kg
- Gross weight: 41 kg

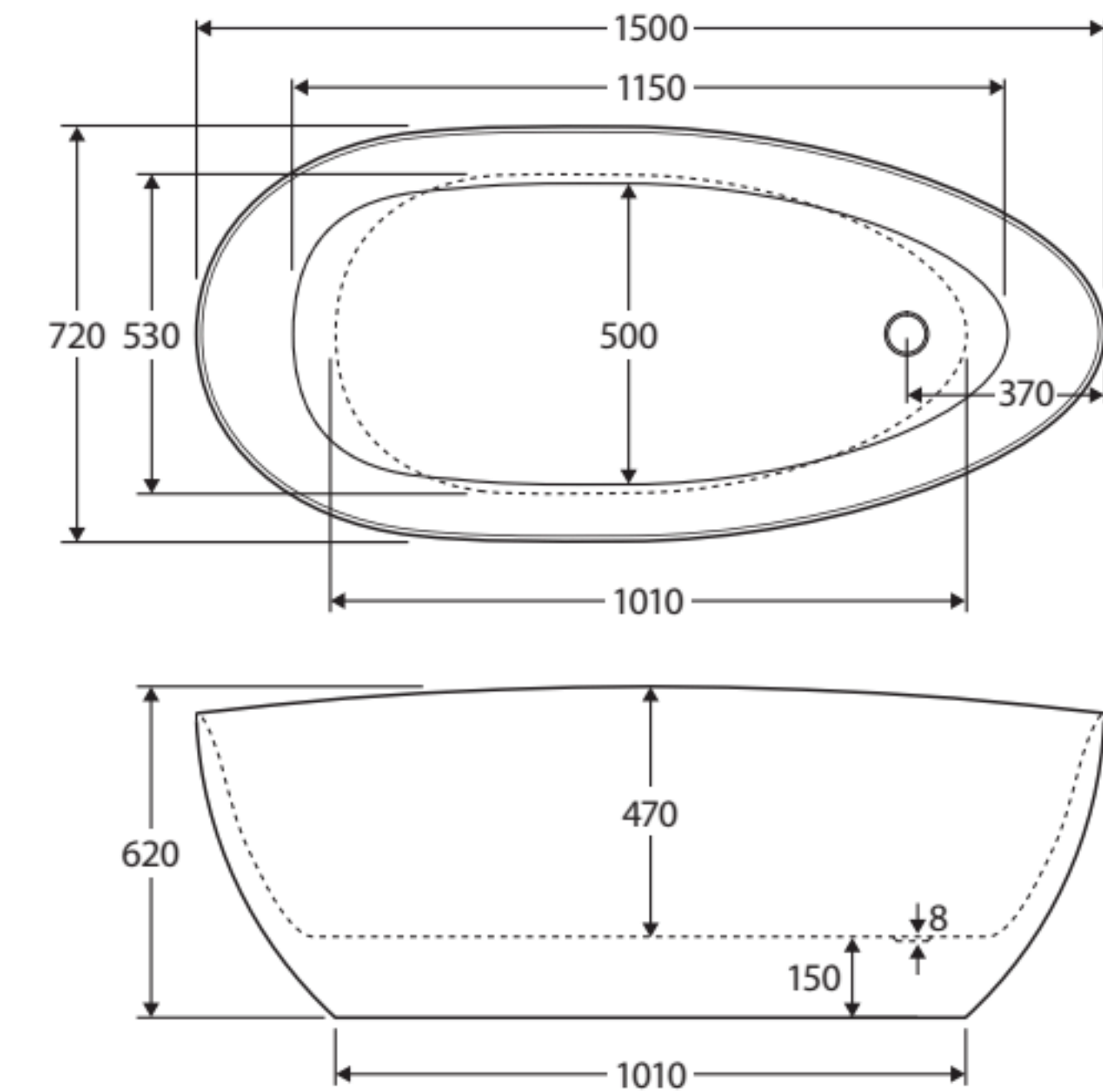

### Available in



Gloss White  
**FR94-1500**

### Cleaning & Care

- Regularly clean with mild soapy water using a microfibre cloth. Weekly cleaning is recommended.
- Do not use harsh detergents, bleach, cream cleaners, window cleaning sprays, or citrus based cleaners.
- Do not use undue pressure and wipe in one direction only.
- If using coloured essential oils, test in an inconspicuous area with water to ensure they won't stain the bath. Always add oils to a bath full of water.

While we aim to ensure specifications are correct at the time of publication, Fienza reserves the right to make modifications without prior notice. Physical colour may vary from image shown. All measurements are shown in millimetres. Always use physical product measurements for mark-ups and roughing-in as the technical drawing may differ from actual product received.